

# SOCIAL REPORT 2020

## ETERNO IVICA FOR SUSTAINABLE DEVELOPMENT

Guidelines and principles:

Social Responsibility - Safety - Environment - Quality

eternoivica

30/07/2020

ETERNO IVICA S.r.l.



PEDESTAL



WOODECK



INSIDE



ETERNO



LIQUID



MONDIAL



VENT



ACUSTICA



PHONOLOOK

# Index



**1 Social Report** pag. 01



**2 Company** pag. 02

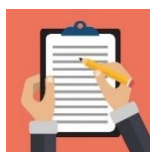

**3 Management System Policy** pag. 08



**4 Stakeholder** pag. 10



**5 Main economic data and investments** pag. 12



**6 The product** pag. 13



**7 Employees** pag. 19  
Child labour, Forced or compulsory labour, Health and Safety, Freedom of association and the right to collective bargaining, Discrimination, Disciplinary practices, Working Hours, Remuneration



**8 Community** pag. 25



**9 Environment** pag. 28



**10 Integrated Management System** pag. 33



# 1 SOCIAL REPORT

**Eterno Ivica** wishing to pursue a consistent and transparent dialogue with all the internal and external stakeholders involved, publishes an annual Social Report since 2006, providing information about its policy.

**The report** refers, in addition to corporate **social responsibility**, also to the **environment** in accordance with sustainable development promoted by the Company policy. It also provides information about the actions involving its stakeholders in compliance with the **Integrated Management System: Quality - Environment - Ethics – Safety**.

Through the **Social Report** we share information about our corporate, commitments, activities and organization, programs and objectives. Everything we do is underpinned by our commitment to operating according to the principles of social responsibility and environmental sustainability.

**Eterno Ivica is certified by the Certification Body DNV GL for the standards:**



**ISO 9001 since 1999**



**ISO 14001 since 2014**

During 2019 **Eterno Ivica** maintained all the certifications and positively passing the third-part external audits.



**SA 8000 since 2007**

**Eterno Ivica** aims through this path to stand out as a Company that pursue socially valuable programs oriented to environmental sustainability and respect for social rights in the whole production process, in compliance with the requirements relating to:

- **Child labour - Forced or compulsory labour - Health and Safety**
- **Freedom of association and the right to collective bargaining - Discrimination**
- **Disciplinary practices - Working hours - Remuneration**

Copy of this document has been provided to the SA8000 Workers' Representative and is available inside the company for consultation by any interested parties. The Social Report has also been published on the company website [www.eternoivica.com](http://www.eternoivica.com) for consultation by other stakeholders and all the stakeholders have been informed about the new publication by newsletter.



**Products and solutions for architecture and building, designed and manufactured in Italy, sold worldwide**

Eterno ivica is a company that for over 60 years has been working in the field of private, industrial building and architecture, the company is distinguished by the high degree of quality and innovation.

FOR OVER  
**60**  
YEARS HAS  
BEEN  
WORKING  
IN THE FIELD  
OF  
BUILDING

OVER **50** EMPLOYEES

MORE THAN **25** MILION EURO OF TURNOVER

BUSINESS RELATIONS WITH MORE THAN **60**  
COUNTRIES IN THE WORLD

## Our history

|   |             |             |   |
|---|-------------|-------------|---|
| The patent is filed for the "Eterno" drain. The first roof drain for rainwater entirely made of rubber.   | <b>1972</b> | <b>1955</b> | The birth of I.V.I.C.A Venetian Industry Tar waterproofing and Allied Products "Industria Veneta Idrofughi Catrami ed Affini" by Favero Ruggero.  |
| Eterno Ivica S.p.a. was established by merging the former two companies.  | <b>1980</b> | <b>1973</b> | The company Eterno S.A.S. was founded Dedicated to producing "accessories for waterproof membranes".  |
| The patent was filed for the "Genius" Roof Drain. The first roof drain for rainwater with a "perforated flange"   | <b>1998</b> | <b>1988</b> | The "Maxisostegno" A height-adjustable support system for external raised paving was produced and presented for the first time in Italy.  |
| Plastic Plus group was established. Eterno Ivica, Italtronic and Plastic Planet merged in order to share experiences and know-how and create important organisational synergies   | <b>2002</b> | <b>2001</b> | The patent was filed for the Self-levelling Support. The patent was filed for the first original height-adjustable support for external raised paving, with a self-levelling and tilting head   |
| The patent was filed for the bicomponent Head (PP+rubber). The patent was filed for the first original support for external raised paving, with bicomponent PP+rubber head  | <b>2009</b> | <b>2003</b> | New headquarters were built in Via Austria, in the industrial area of Padua - Italy   |
| "Liquid" was created. The innovative "Liquid" roof drain line was created, specifically designed for application with liquid sheaths and mono/ bicomponent resins   | <b>2011</b> | <b>2010</b> | The range "New Maxi" was created. The historic line of height adjustable supports "Maxi Sostegno" is renewed with the new and modern line "New Maxi"  |
| The patent was filed for the TXT, the first entirely recycled and recyclable soundproofing product. The patent was filed for the START, the only support in the world adjustable from 8 to 15 mm.   | <b>2015</b> | <b>2013</b> | The new "Acustica" line. This year, important investment has been made in the field of sound insulation for buildings, with the creation and production of a new line of "Acustica" products  |
| Phonolook: the new line of Eterno Ivica declined in two product ranges: Phonolook Design and Phonolook Solution.  | <b>2017</b> | <b>2015</b> | Acquired DANI SYSTEM Company and the RUMOR BLOCK Brand.   |
| Launch of the new PHONOLOOK 3D panel. New Phonolook 3D line presented for the first time at Klimahouse 2019. The panels are characterized by a coating with embossed fabric able to give them shape and volume without depriving them of the main sound-absorbing function. | <b>2019</b> | <b>2018</b> | New Windproof System, the patent was filed. The patent was filed for the new safety plate. The safety plate consists of a 2 mm thick galvanized steel sheet, suitably shaped in order to support the flooring elements in the event of accidental breakage. |
|   |             | <b>2020</b> | Eterno Ivica celebrates 65 years of activity. Since 1955 Eterno Ivica has been active in the building sector and in architecture obtaining the role of leading company in Italy and worldwide.  |

## Our headquarters



The **Eterno Ivica** manufacturing site covers a total area of over 10,000 square meters, of which 7,000 are indoor, divided into three production units directly connected one to the other, with testing laboratories and interior design studios. To share ideas and build success.



**Eterno Ivica** is a company that for over 60 years has worked in the building market producing accessories and components for many sectors, in each of which the company is renowned for its high degree of specialization and innovation of the proposed solutions.

**Eterno Ivica** has different injection presses from 50 to 512 tons of different characteristics that can guarantee a production capacity able to satisfy a wide range of commercial requests. All the presses are equipped with steering units which ensure absolute control of the process in a simple and immediate manner. The presses are equipped with numerically controlled robots, auxiliary exsiccation systems, dehumidification and automatic granule transport. At the end of processing, the testing and the setup of the equipment are carried out. All the molds are tested internally in order to verify the perfect functioning through the production.

**Internal design and production processes enable Eterno Ivica to satisfy needs of customers in a dynamic and flexible way.**

## Our products line

The wide range of products, designed and produced entirely in Italy, is divided into 8 lines and includes: support for raised flooring, substructures for outdoor decking, accessories for flat roofs waterproofing and liquid systems for sewage water, equipment for the installation, acoustic silencers and ventilation of rooms, services and products for soundproofing and silent ventilation and aeration.



Adjustable supports for exterior elevated floors.



Drain boxes, channels and other products for water drainage.



Outdoor substructures for all kind of decking.



Innovative solutions for silenced and natural ventilation.



Roofing accessories for roofs and balconies waterproofing.



Products for sound insulation and sound absorption.



Accessories for liquid waterproofing.



Design solutions for sound absorption.

All **Eterno Ivica** products are designed and manufactured entirely in Italy. Style, design, taste, attention to detail and Italian excellence distinguish our systems, distributed through a network of exclusive distributors and appreciated throughout the world.

# MADE IN ITALY

**Today we can thus formalize the Eterno Ivica mission:**

offering to those working in the construction field our own expertise and experience in the field of plastic products, in order to provide technically excellent products in target market segments, respecting ethical values, the environment and the health and safety of workers.

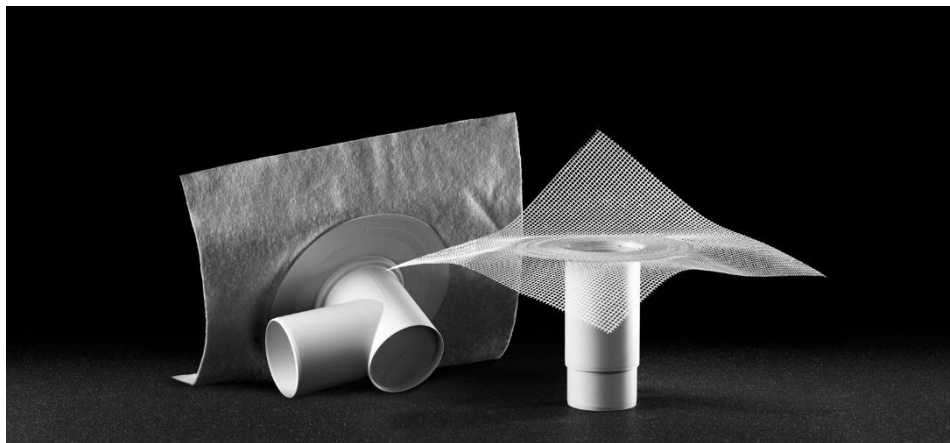





MONDIAL



V E N T

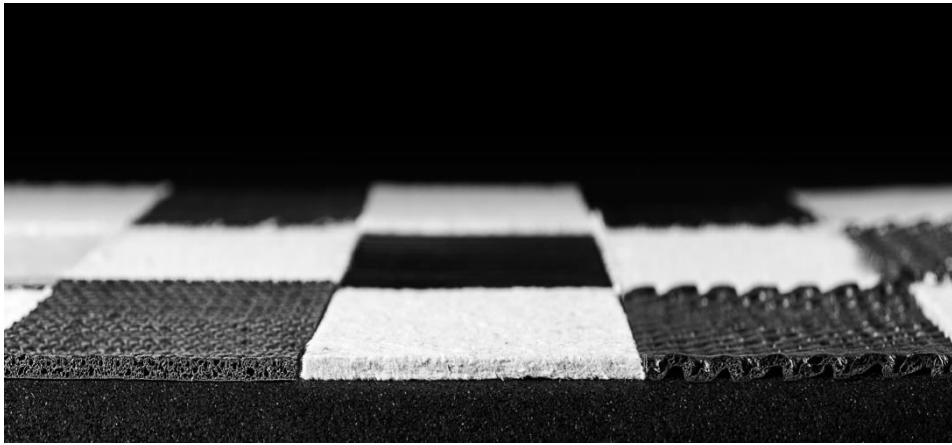

ACUSTICA



PHONOLOOK



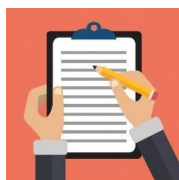

### 3 MANAGEMENT SYSTEM POLICY

**Eterno Ivica**, in order to grant a service oriented to customers, workers and all interested parties, while constantly increasing its business results, has set the goal to tenaciously pursue the highest possible quality in all areas and factors influencing the development of the Company:

#### **Community, Leadership, Employees, Process, Product and Service**

The guiding vision of the group's policy is

##### **total quality to ensure:**

- full satisfaction of the customer and stakeholders, i.e. active and appropriately understanding their needs;
- adequacy of facilities and human resources;
- respect for the environment;
- respect for human rights;
- respect for ethical values and health and safety at work;
- constant commitment in the prevention of pollution and continuous improvement of environmental aspects in terms of: saving energy and natural resources, proper waste management and recovery, constant monitoring of emissions into the atmosphere;
- personnel trained and equipped to respond quickly to emergencies;
- constant risk management for all activities/products and services in order to promptly recognize the problems or opportunities.

The most important elements in order to achieve this policy are:

- considering all the employees as a valuable resource:
  - ✓ always respecting the requirements of SA8000 rule relating to: child labour, forced or compulsory labour, health and safety, freedom of association and the right to collective bargaining, discrimination, disciplinary practices, working hours, remuneration, ethical code, together with the Universal Declaration of Human Rights and ILO documents and actions promoting respect for human rights
  - ✓ encouraging workers' professional growth and awareness of their own role and actions through appropriate training processes to teach respect for human and moral rights and for the prevention of accidents and occupational diseases
  - ✓ involving the employees and facilitating their active participation in the application of the policy, through the establishment of committees made up of managers and workers, to assess and propose corrective actions and improvements in social and security system
  - ✓ involving the employees in environmental management to increase awareness of the appropriate behaviours that must be implemented, especially in waste management, paying attention to resource consumption and to the use of hazardous substances in any emergency situation.
- considering the suppliers as strategic partners working together to achieve:
  - ✓ the careful choice of materials and technological innovation
  - ✓ the constant improvement of quality of the final product
  - ✓ the compliance with requirements relating to social and ethical issues, safety and environment
  - ✓ the assessment and prevention of risks of a potential non-compliance

- considering the customers and the community as an incentive for high quality service, constantly seeking their satisfaction in terms of social responsibility and environmental management, providing them with an active and transparent communication of objectives and performances through the publication of the Social Report on the website and supporting initiatives to involve the stakeholders, assuring them:
  - ✓ the compliance with applicable laws, contracts, agreements and other requirements in the social, ethical and environmental fields
  - ✓ the effective commitment to continuously improving the ethical, social and environmental performance
  - ✓ the prevention of workers' health and safety in the workplace and the protection of environment.
- ensuring the continuous monitoring and improvement of the Integrated Management System, defining measurable improvement objectives and verifying the achievement and effectiveness.

Mandatory conditions for achieving this goal are:

- clarity of roles
- a high level of professionalism demonstrated by individuals
- a high reliability in materials and equipment
- stimulating climate, i.e. a workplace environment where positive relationships between people encourage working in a comfortable, dynamic and proactive context, that leads to fulfill the seek for high quality of the whole group
- building relationships based upon fundamental principles that refer to the values:

RESPECT, INVOLVEMENT, HUMILITY, AVAILABILITY AND HONESTY

- developing a work philosophy based on the team spirit with the purpose of:

**<WORKING TOGETHER FOR SUCCESS AND SATISFACTION>**

The General Management is committed to pursuing and maintaining the company policy and constantly encourages the parties involved to follow it.

**Eterno Ivica** provides evidence of the application of this policy through documented information in compliance with the rules UNI EN ISO 9001 - SA 8000 - UNI EN ISO 14001 - UNI ISO 45001 - Linee Guida Inail per un sistema di gestione della salute sicurezza sul lavoro (SGSL).

**The Integrated Management System is certified for the rules UNI EN ISO 9001 - SA 8000 - UNI EN ISO 14001.**

| Riferimenti  | Fax o sito internet  | e.mail   |
|--|--|--|
| Responsible for the Integrated Management System<br>SA8000- ISO14001 and ISO9001 of Eterno Ivica<br>Via Austria n. 25/E 35127 Padova - Italy | Reports and complaints<br>+ 39 049 8530173<br>www.eternoivica.com  | d.vescovo@eternoivica.com  |
| DNV GL - Business Assurance Certification Body<br>Via Bruno Maderna7 5th floor - Torre Eva 30174<br>Mestre (VE) Italy                        | +39 041 5060655<br><a href="https://www.dnvgl.it/contatti/Form-Segnalazioni-Reclami.html">https://www.dnvgl.it/contatti/Form-Segnalazioni-Reclami.html</a> | <a href="http://www.dnvgl.it/contatti/Form-Segnalazioni-Reclami.html">www.dnvgl.it/contatti/Form-Segnalazioni-Reclami.html</a> |
| SAAS - Accreditation Body SA 15 West 44th Street,<br>6th Floor New York NY 10036 -   | Fax (212) 684-1515<br>ww.saasaccreditation.org   | saas@saasaccreditation.org   |
| Accredia - ISO Accreditation Body<br>Via Tonale, 26 - 20125 Milan Italy  | Fax. +39 02 21009637<br>www. accredia.it   | milano@accredia.it   |

General Management

**Favero Gabriele**



## 4 STAKEHOLDERS

Below we present the stakeholders identified by **Eterno Ivica** in order to ensure the capacity to meet all needs and requirements through an open, transparent dialogue based on trust:

**Human Resources**  
**Partners**  
**Customers**  
**Suppliers**  
**Financial institutions**  
**Civil community**  
**Public administration**  
**Environment**  
**Means of communication**

This Social Report was drawn to meet management systematic review procedures and external communication requirements and is the result of the participation of social partners to the implementation of the social and environmental responsibility system.

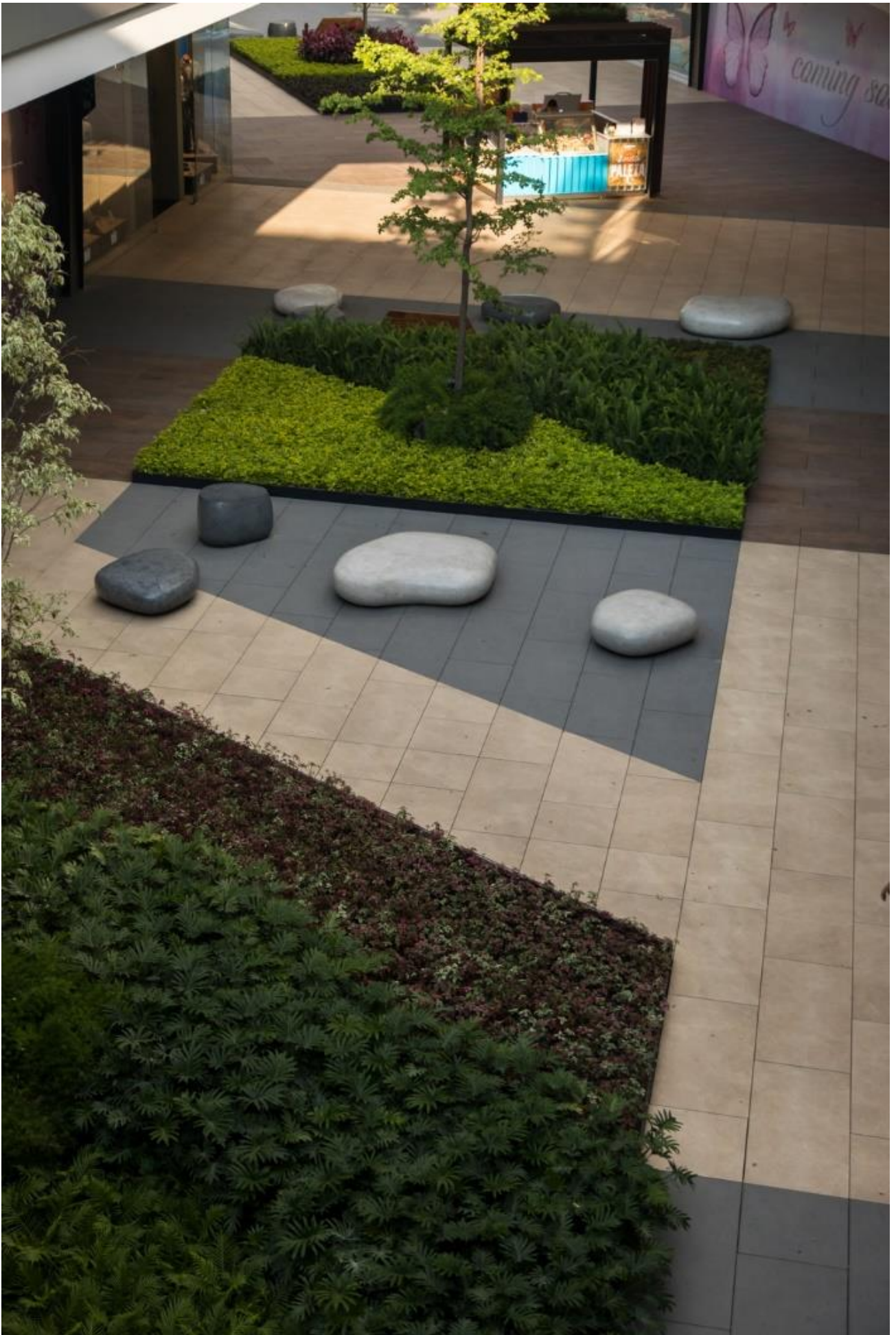



## 5 MAIN ECONOMIC DATA AND INVESTMENTS

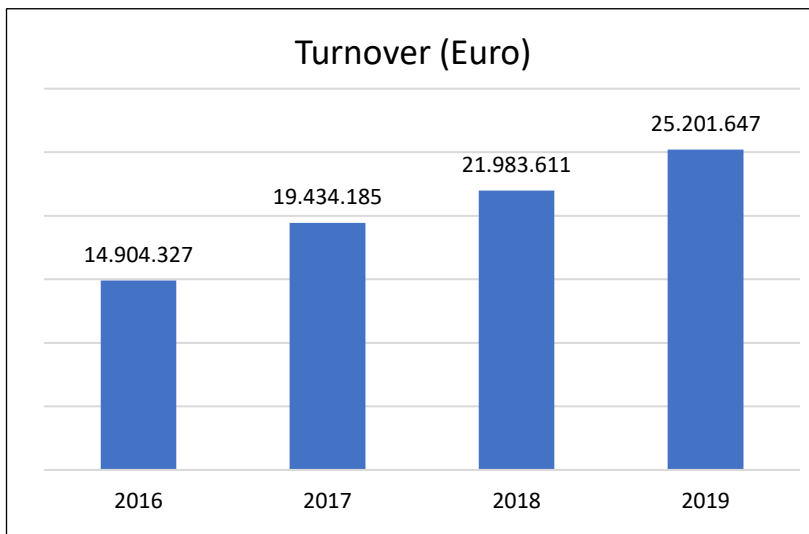

The 2019 results show a +14,6% increase in turnover compared to the previous year.

2019 closed with a consolidated turnover of just over 25 million euros, recording an increase of + 14.6% compared to the previous year.

The excellent performance confirmed an important growth in volumes and turnover. Italian customers contribute to the realization of 30% of the turnover while the remaining 70% is produced by customers coming mainly from Germany, France, the United States, the Middle East, the United Arab Emirates and Australia. The export share is constantly increasing especially in markets such as the USA, New Zealand and Australia.

The results for the 2019 financial year highlight **Eterno Ivica's** commitment to continuous growth.

- **from December 2018 Eterno Ivica acquires, through a merger by incorporation, the molding company Plastic Planet.**

Furthermore, the relocation of the headquarters and the sale of the Italtronic business allowed Eterno Ivica to expand its warehouse and its offices.

The new strategic structure has allowed Eterno Ivica to:

- duplicate the extension of the warehouse area allowing for better organization and coordination at the logistic level;
- interacting directly with the plastic molding department, reorganizing the internal layout of the injector machines and making new investments in the robotization of the packaging process.

- **Investments in process automation and new machinery**

In 2019 Eterno Ivica made investments in technologies and machinery to be able to automate the most repetitive processes, including for example packaging, optimizing times and increasing the level of efficiency.



## 6 PRODUCTS

### OUR GOAL IS TO SPREAD THE QUALITY OF OUR PRODUCTS TOWARDS A GLOBAL MARKET

The primary goal of **Eterno Ivica** is to ensure the highest quality, reliability and safety. The efforts aimed at achieving quality and continuous improvement, constant control on raw materials and finished products undergoing specific tests, attention to the quality of processes and the orientation towards the client are proven by the ISO Certification 9001: 2015.

**Eterno Ivica** believes that not only consumer products but also industrial ones must be designed to have a pleasant aesthetic as the market, worldwide, requires the synthesis between beauty and functional quality, between style and effectiveness.

### Sales net

**in Italy: more than 40 agents**  
**worldwide: more than 49 distributors and 14 agents**

### Our customers appreciate

- ✓ Flexibility of special requests.
- ✓ Maintenance of the commitments undertaken.
- ✓ Product quality.
- ✓ Production process versatility.
- ✓ Technical capacity.

## News in the products

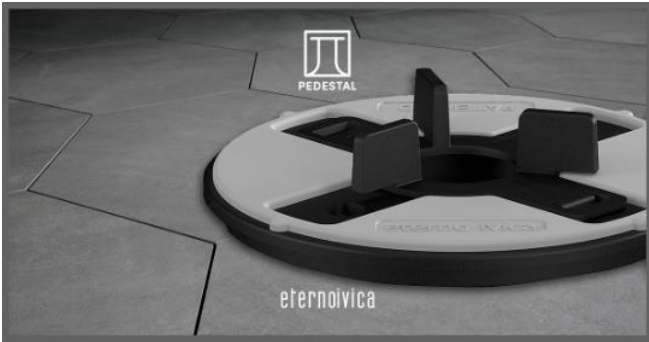

The **clips for the installation of hexagonal plates**, previously produced in steel, have been modified in **100% recyclable polypropylene** for greater **versatility** and **flexibility**.

With the **simple** and **quick** application of a small polypropylene clip on the **standard heads** (110mm) of **SE** and **NM** supports, we can meet the creative needs of **architects** and **customers** who see in the hexagonal plates a possible and imaginative **aesthetic solution** for the realization of raised floors for outdoor use.

Innovative and latest-generation techniques have been used to improve the **performance** of the various sound-absorbing panels. Some of those innovations have already been presented, like the innovative **Phonolook 3D**, while others are still waiting for you!

An **absolute novelty**, indeed, in this regard is **THE BREATH technology**. It is an innovation which combines **sound quality with healthy air**.

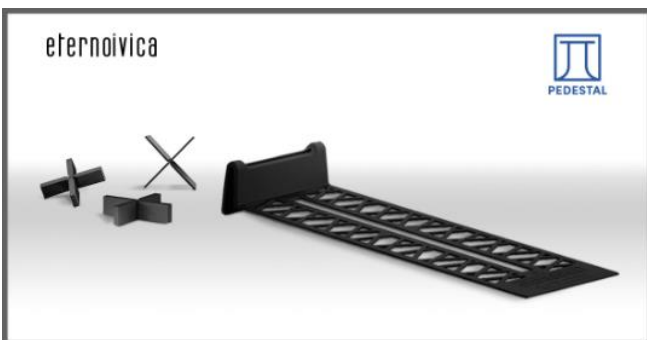

### **Pedestal line is updated with two new products**

The first product is added to the already numerous solutions of **non-adjustable supports** of the Pedestal line. The cross spacers CR offer a very simple and versatile system to install the plates on sandy ground.

The **spacer** is a classy detail that allows to space the flooring plates from the perimeter walls in an elegant and uniform way, offering the maximum guarantee of stability.

The **new spacer** is produced entirely in **100% recyclable polypropylene** for greater versatility, the material allows a softer support on the tile and avoids possible annoying noises between the plates and the underlying structure.



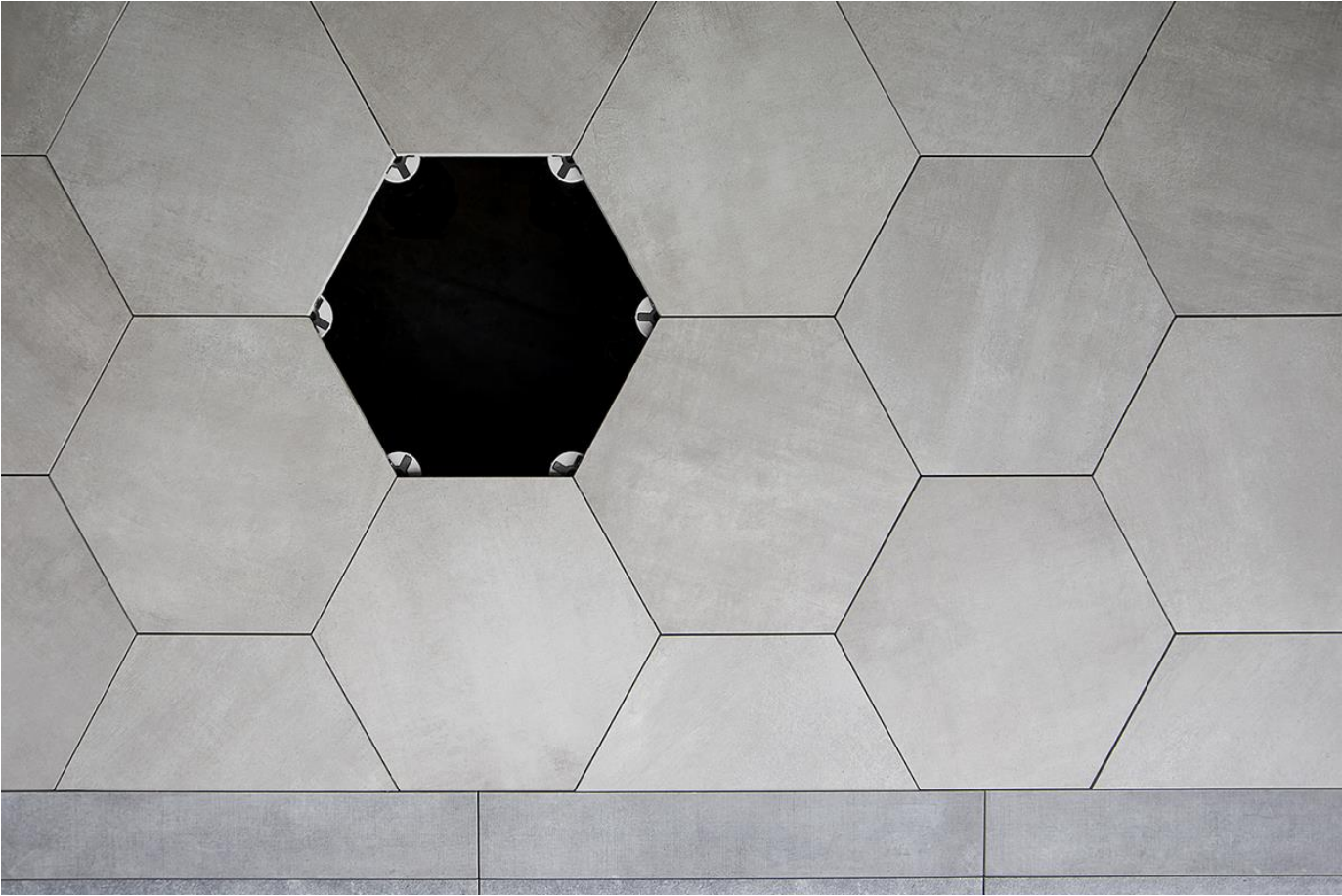

## Assistance

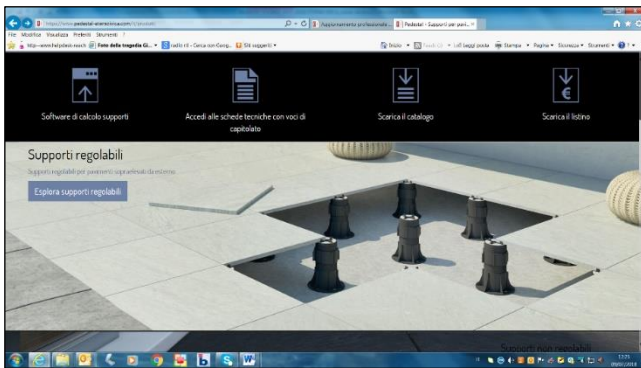

The **calculation software** is a very important tool that helps you in the **installation**, correct **positioning** and **proper number** of the Pedestal and Woodeck supports.

The eye-catching graphics, technical controls and ease of consultation will allow you to proceed **quickly** and **easily**.

## Service

An advanced system of integrated geolocation is active for requesting estimates and information, which allows you to send requests for estimates directly from product pages



## Traceability



Eterno Ivica **complies with EAN international coding system** for all its products.

Eterno Ivica aligns itself with the international product coding guidelines to satisfy customers and distributors need to allow and improve greater retail sales of its products.

## Communication

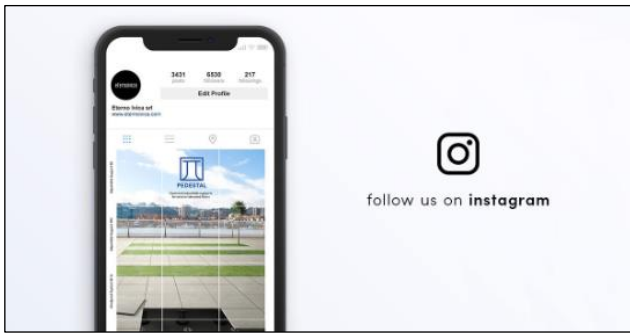

Now you can find the whole **Eterno Ivica's world** on a new, totally innovative and trendy **social page**.

**Instagram is waiting for you!**

**Follow us** to discover all the **events** and **news** of our product lines.

You can scroll through images and photos, tag us at important events and follow our stories in which we will tell you what is going to happen!

You will always be **up to date** and always keep up with the **news!**

**Follow us @eternoivica**

## Magazine

**Now**, we can tell you about the many **requests for collaboration** received this year, articles on stories and projects that we constantly publish in **Italian** and **English** (because we strongly believe in internalisation and 360 ° distribution) and the most significant events, such as exhibitions - shows - architectural events, which we like to share to keep you informed.

In short, **ARKT** is strongly online, it is cured and followed in detail and is also constantly updated on **social media**.



## Fairs



**Eterno Ivica** is present in all the most important trade shows in the sector.

## Events

**Eterno Ivica** promotes **training seminars** and **conferences** in many Italian provinces, aimed at professionals who face problems of acoustics and phono isolation and to present in many **Workshops** the raised outdoor flooring and new products.

**MARTEDÌ  
10 DICEMBRE  
2019**  
DALLE 14.00  
ALLE 18.30





evento realizzato con il contributo incondizionato di



**SEMINARIO IN MATERIA ACUSTICA:  
MIGLIORAMENTO DEL COMFORT  
ACUSTICO NEGLI AMBIENTI CHIUSI**

PRESSO SALA CONVEGNI "ZAIRO" ORDINE DEGLI ARCHITETTI, P.P. E C. DI PADOVA

## Eterno Ivica adheres to producers Association

### Partner

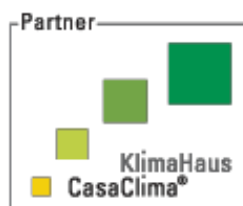

### Associated



### Academic partner





## 7 EMPLOYEES

This paragraph is intended to show the situation of **Eterno Ivica** in relation to WORKERS and to the fulfilment of all requirements of the SA8000:2014

The review by the General Management has verified the results achieved in 2018 and set targets for improvement related to Social Responsibility to be reached in the year 2019.

### Child labour

There are neither children working in the Corporate, nor young workers as defined in the standard SA 8000 (from 14 to 18 years).

All employees are adults. The emitted procedure for this topic is applied and respected.

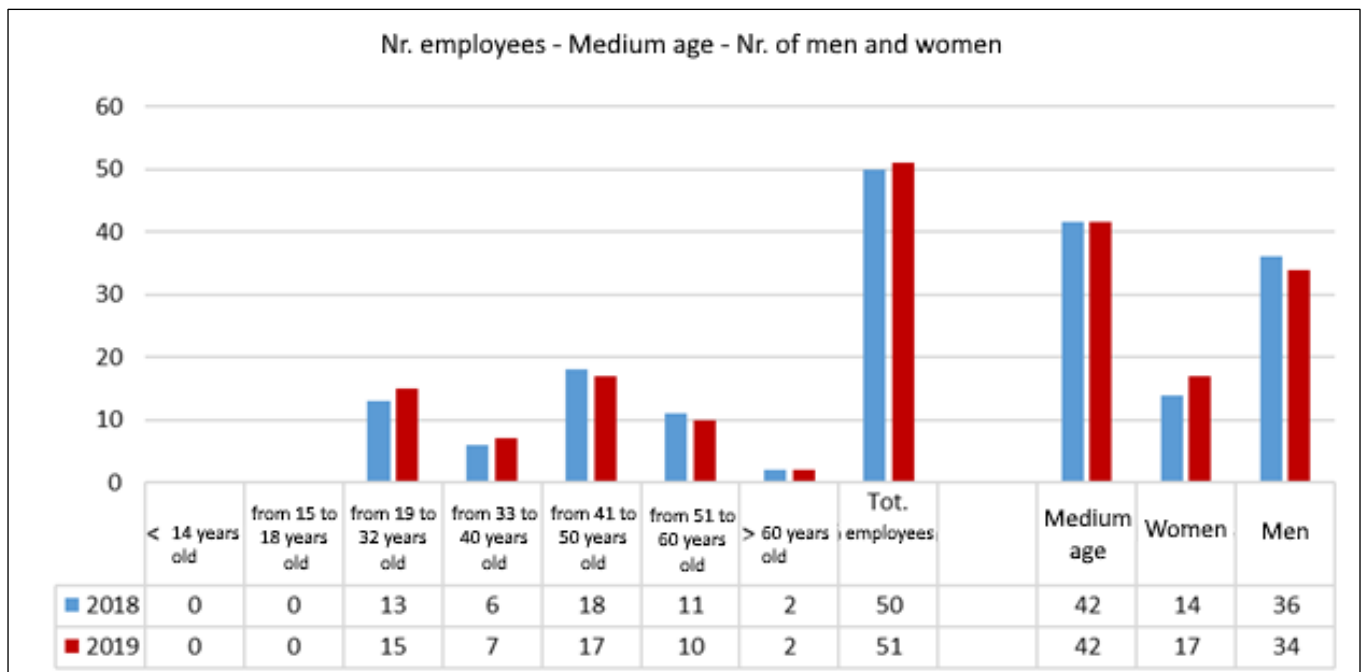

### Forced and compulsory labour

Workers work voluntarily, no one is victim of threats or other intimidation that force him in any way to work for the company.

Workers do not leave to the company amounts of money or personal original documents.

Employees upon recruitment are informed on how to resign, they receive and sign for acceptance all documents required. They are also informed about the Rules of Conduct.

## Health and Safety

The Company refers to and applies all regulations governing workers' health and safety and a healthy and safe working environment.

**Eterno Ivica** has an updated risk assessment, is covered by evacuation and fire control plans; in each workplace the emergency procedures are readily accessible on notice boards, and also the names of the workers that for each site have been trained through appropriate courses to handle with emergencies.

The (periodic) health examination offered to employees are carried out according to the sanitary plan made by the competent doctor.

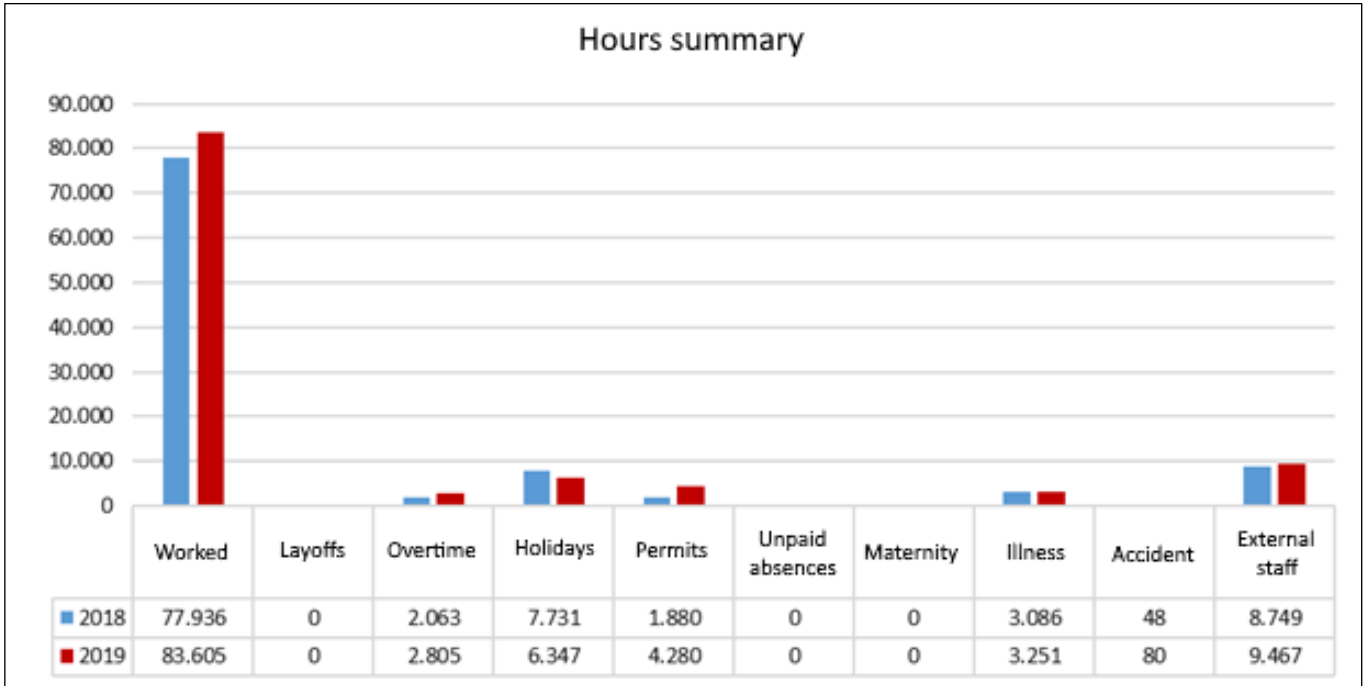

Absences due to illness or injury are constantly monitored for all the companies belonging to the group; such information are of key importance in order to identify the possible causes and eventually undertake the appropriate remedies.

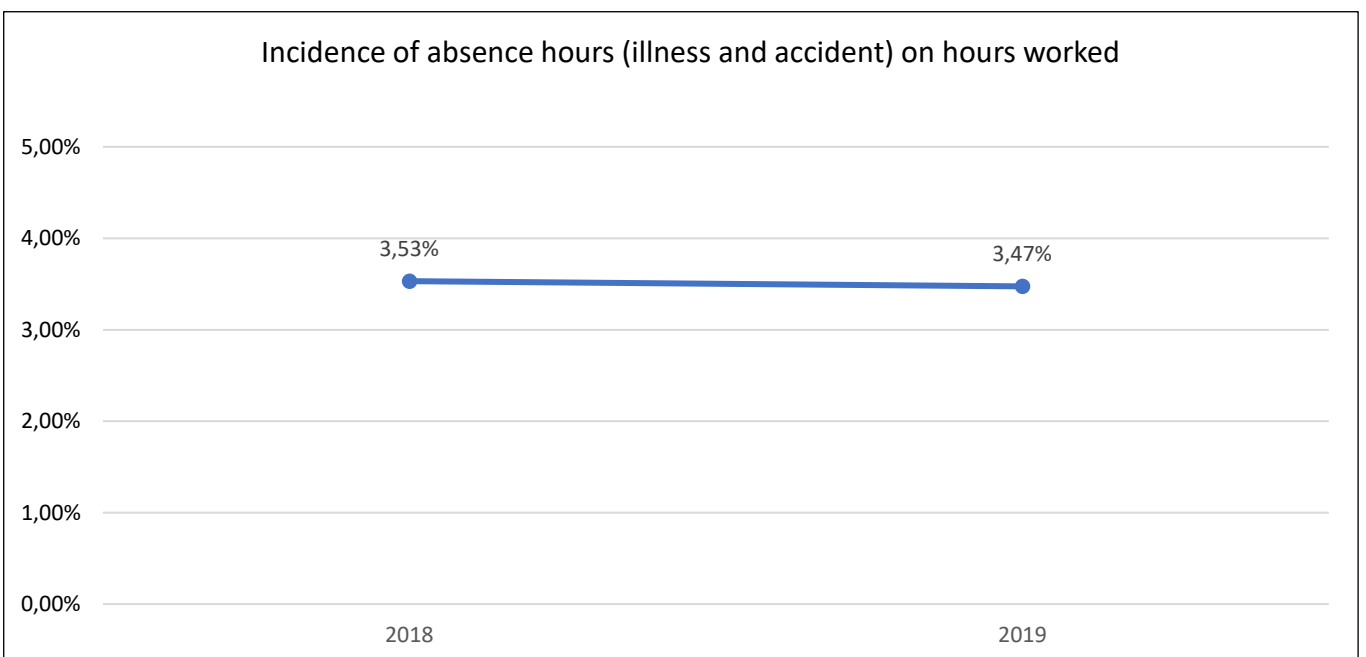



## Safety training courses carried out in 2019

In 2019 they were disbursed to our staff the following courses:

- evacuation test in case of emergencies with all employees;
- spreading of hazardous substances with emergency teams;
- updating and training of two new “preposti”;
- RLS training for companies with more than 50 employees;
- sensitization to work in safety for all forklift operators
- first aid training new employee
- high risk firefighter training;
- update for forklift operators

The number of hours dedicated to safety training in 2019 was 209,5 hours..

## THE NUMBERS OF HOURS DEDICATED TO SAFETY TRAINING

IN 2019 WAS **426** HOURS

## Results on goals 2019 on Safety at Work

Security improvements planned and implemented in 2019  are reported:

- Reorganized the production department tasks, after merging Plastic Planet into Eterno Ivica, in particular by identifying the personnel in charge of changing the molds.
- Reorganized the fire control and emergency device control in the production department.
- Fixed the door under the canopy.
- Appointed Grazian Manuel and Lovison Luca “preposti”.
- General Risk Assessment Document updated following the merger of Plastic Planet into eternal Ivica.
- Physical risk Assessment Document (noise and vibration) has been updated.
- Carried out spreading of hazardous substances with emergency teams.
- Carried out evacuation test in case of emergencies with all employees.
- Make new emergency officers appointments based on the new structure.
- Visitor guide issued.
- The new Safety Manuals for warehouse, offices and production have been issued containing instructions for working safely and to prevent the risks of accidents.
- The Company Regulations (IG 06) have been updated and delivered to all employees at the year-end General Management meeting. It should be noted that in order to improve safety in the workplace, the prohibition to transit in areas not pertinent to one's work, if not authorized, was highlighted in said Regulation.

## 2020 new goals for the workplace safety

The Health and Safety Committee (CSS), jointly with the SPT Committee (Social Performance Team), the Prevention and Protection Manager (RSPP), the doctor and the safety consultant, have assessed all the risks associated with processing and to the plants as set forth in art. 35 paragraph 2 of Legislative Decree 81/08 (reference Report of the periodic meeting on security and review) and planned all the security adjustment and improvement activities that emerged during the periodic meeting.



## Freedom of association and the right to collective bargaining

The Company respects the right of workers to form and join trade unions of their choice and the right to collective bargaining, while fully respecting the norms and national agreements.

All employees of the organization are absolutely free to communicate with their trade union members in the workplace, in accordance with the provisions for access and the security of such places.

Starting from November 2019, a part of the workers joined the CGIL FILCTEM union and elections were held on 19/11/2019 to elect the Unitary Union Representatives. The members of the RSU will remain in office for three years.

**The Workers' Representatives were informed that, on request, the company makes available the facilities necessary for communication and for carrying out the trade union meetings.**

## Discrimination

**Eterno Ivica** does not implement any kind of discrimination against its employees, it guarantees equal opportunities to all employees and does not implement or permit interference in their private lives.

In **Eterno Ivica** the 16% of workers are foreigners coming from various countries outside Europe, who are sufficiently integrated with the workplace and are able to understand and express themselves in Italian at an autonomous stage.

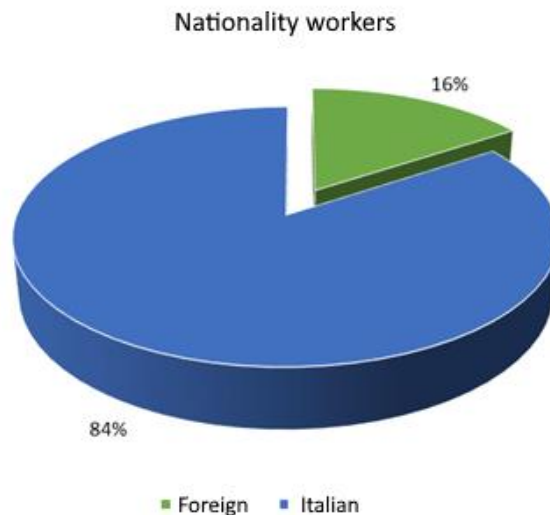

## Disciplinary practices

**Eterno Ivica** is inspired by the code of ethical behaviour and does not resort to any form of physical or mental coercion, verbal abuse or any offense against the personal dignity of any employee or collaborator.

## Working hours

**Eterno Ivica** employees of the office and warehouse area work on a one work shift, while the operators of the plastic molding department work on three work shifts.

The duration of the working activity is fixed, as per contract, in 40 weekly hours with a maximum of further 12 overtime hours.

Working hours are stated, as per contract, to be 40 hours per week with a maximum of 12 additional hours of overtime. Currently there are no claims or reporting for imposition of overtime and the indicators are continuously monitored.

## Remuneration

The work is paid as set by the National Collective Labour Contract for Industry Rubber and Plastic.

### 2019 Activities:

- Contractual and salary levels are determined for workers according to their role and position.
- All employees, depending on the operating framework, receive the incentive bonuses.
- During 2018 fuel cards have been given to all employees.
- As in last years it has been offered the chance to use a gym inside the workplace.

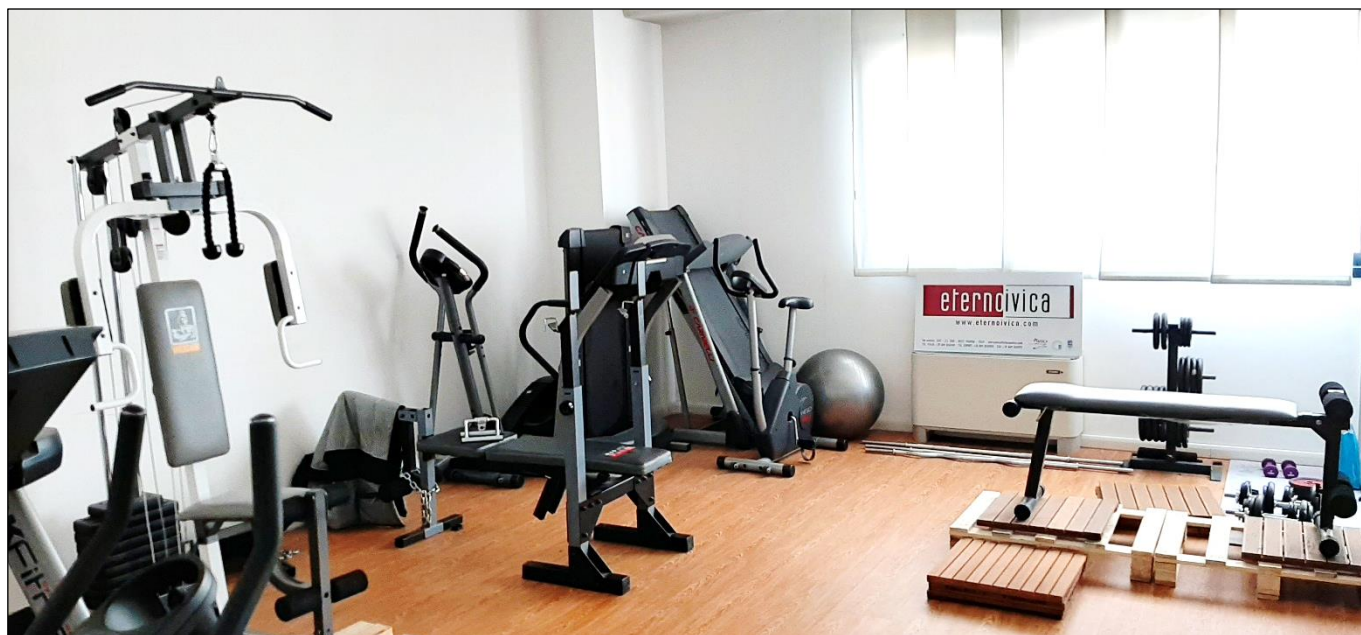

| Type of employment in 2019 (to 31/12/2019) | Nr.       |
|--|-----------|
| Full-time indeterminate contract           | 45        |
| Part-time indeterminate contract           | 1         |
| Fixed-term contract                        | 5         |
| <b>TOTAL internal human resources</b>      | <b>51</b> |

|                               |   |
|-------------------------------|---|
| Temporary employment contract | 4 |
|-------------------------------|---|

The information is given to workers by delivering to new employees the document "Personal Information Code", a guide illustrating company's policy and describing the characteristics of the labour contract signed, the description of payroll, the internal regulation and rules of conduct, the procedures for the forwarding of complaints or suggestions coming from employees, the standard SA 8000 and the Code of Ethical Behaviour



**8** COMMUNITY

## **Social Commitment of Eterno Ivica with the Project "Building the future together"**



Below are listed all the steps of the Project "**Building the future together**" which ended with the construction of two schools in the St. Maximilian school complex of Dar es Salaam in Tanzania.

### **1st building opened in June 2011**

for the Primary School



## 2nd building opened in July 2013

to host adolescents aged thirteen to eighteen, when they have completed the Primary School. This is a professional training school, with traditional classrooms and laboratories, which can host about 300 students.



## **Contributions to projects of social responsibility**

In 2019, **Eterno Ivica** continued to support the project "Building the Future, Together" and other projects through the following contributions:

CORALE SANT'ANTONIO D'ARCELLA

1.000,00 €

## Collaborations with University

### Casa dell'Energia (House of Energy) - Mirano

The Levi - Ponti Industrial Institute of Mirano, the Metropolitan city of Venice and the Ministry of Education University and Scientific Research have started a project that will revolutionize the idea of building. It is in fact an energy efficient building equipped with the best technologies for the production of energy from renewable sources.

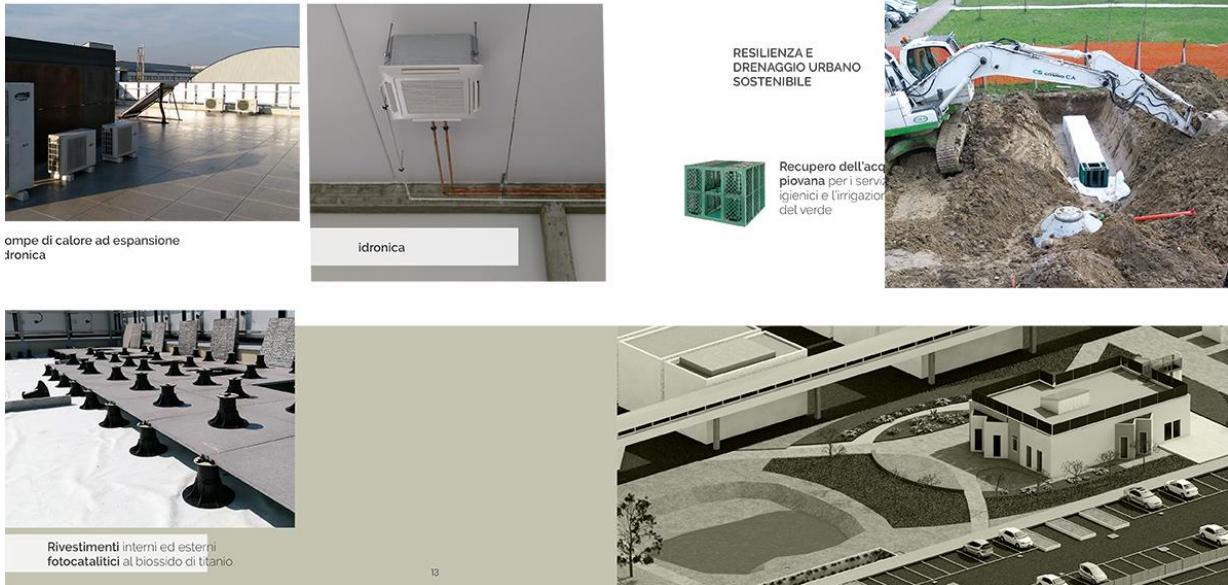

The ambitious project called "La Casa dell'Energia" it is developed inside the school citadel of Mirano-Venezia, where a set of secondary schools create a real Campus able to welcome over 4000 students. The Casa del Sole, due to its location, is conceived as an access building to the Campus and its image opens up to the territory as a real declaration of commitment for a sustainable future that starts from the young themselves.

**Eterno Ivica** is proud to participate as an official partner covering the terraces of this avantgarde building with its supports. Once again, the company is attentive and participates in initiatives of great importance.

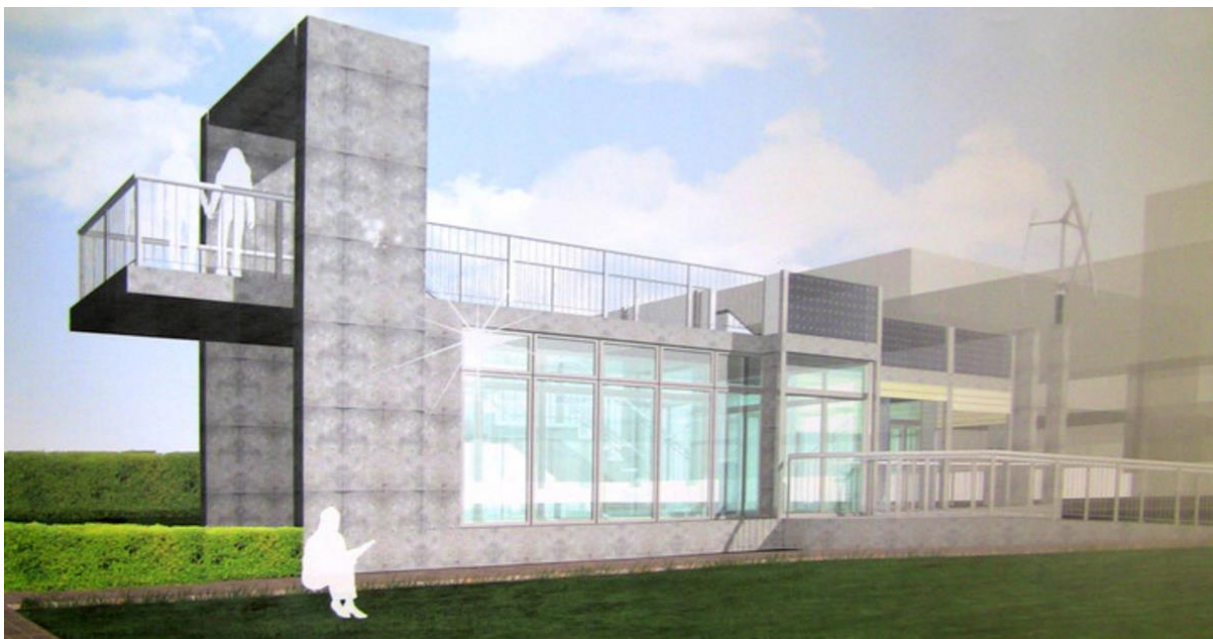



## 9 ENVIRONMENTS

**Eterno Ivica's** policy has always been oriented towards **optimizing the impact on the territory and the environment**. Since 2014 it has been **ISO 14001 certified** with the DNV GL which certifies the company's compliance with a series of internationally coded procedures, aimed at improving the internal environmental management system. The decision to seek this certification **springs from the desire to reconcile quality with efficiency and productivity while protecting the environment** and community in which the company operates

Through the analysis of the context and the assessment of risks and opportunities has evaluated the position of the **Eterno Ivica** in relation to the environment in order to take into account all the environmental aspects/impacts and their management.

For each environmental aspect, the impacts have been evaluated considering the conditions Normal, Abnormal and Emergency. In compliance with the principles of environmental policy, an Environmental Programme has been drawn defining for each aspect, considered important for the sustainability of the territory, specific objectives with timing, goals and actions planned according to the logic of continuous improvement.

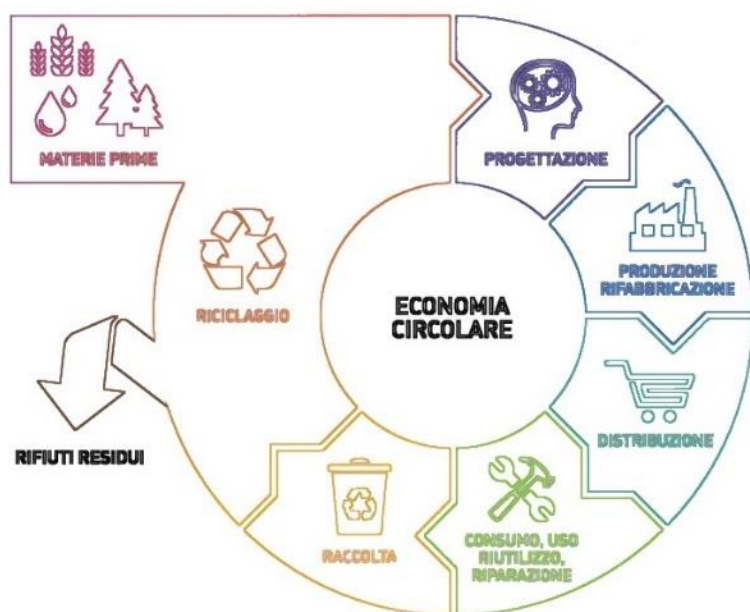

### IS OUR WAY OF WORKING SUSTAINABLE?

This is the question that **Eterno Ivica** addresses to all environmental aspects/impacts and their management. The Company, respecting the environment and taking into account the following principles:

- from pollution removal to pollution prevention;
- from waste management to waste prevention and reduction;
- from increasing the resource use to increasing the resource conservation;

are committed to the following environmental program to be developed over five years, with the following objectives:

**Eterno Ivica** has always paid particular attention to the eco-sustainable aspect of its products and by adopting the objectives of the **Circular Economy** it is constantly committed to its application, starting from the design and choice of materials, to the sustainable management of end-of-life products and waste.

The goal is to "close the life cycle" of products, encouraging reuse and recycling, bringing benefits both economically and environmentally and therefore able to restore value. An economic system designed to self-regenerate and make a big difference.

## RAW MATERIAL

The products are made with fully recyclable raw materials



## PRODUCTION WASTE

**Eterno Ivica** recovers and optimizes the non-conformity products and the sprues by reintroducing into the production process.



## GARBAGE

**Eterno Ivica** pays attention to waste management and workers shall apply separate waste collection of wood, paper / cardboard and plastic packaging, which then are delivered to a specialised company for their recovery and transformation.



## LEED

Since 2013 **Eterno Ivica** realizes the LEED mapping of the product lines "Pedestal" and "Woodeck." The products of these lines are positively integrated in the housing projects with low environmental impact and provide a contribution to LEED® certification for the building.



## REACH

In 2017, to guarantee respect for the environment and human health, **Eterno Ivica** has certified the REACH conformity of the products of Pedestal and Woodeck.



**Eterno Ivica** is committed to follow an environmental program to be developed over five years and has featured the following objectives:

**1<sup>st</sup> long term GOAL**

**Check the incidence of electricity consumption on turnover**

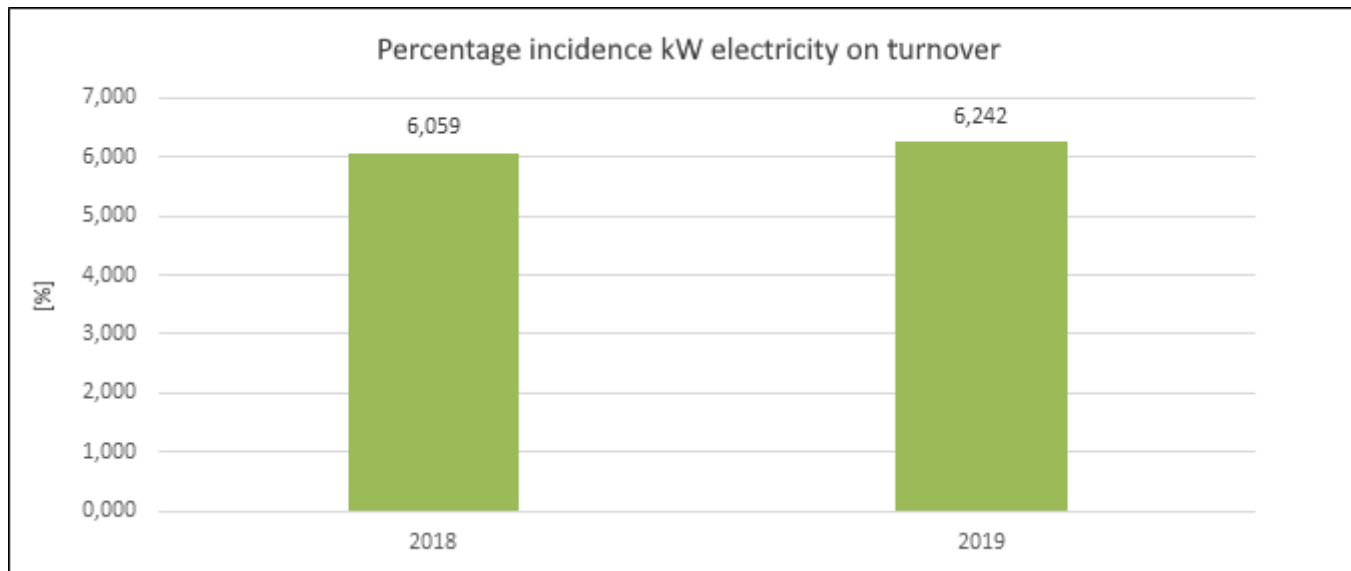

Although constant attention is paid to limiting consumption, in 2019 the incidence of electricity consumption on turnover showed a slight increase due to investments in technologies and machinery for the automation of some production processes.

**2<sup>nd</sup> GOAL**

**Check and improve the separate collection of non-hazardous waste**

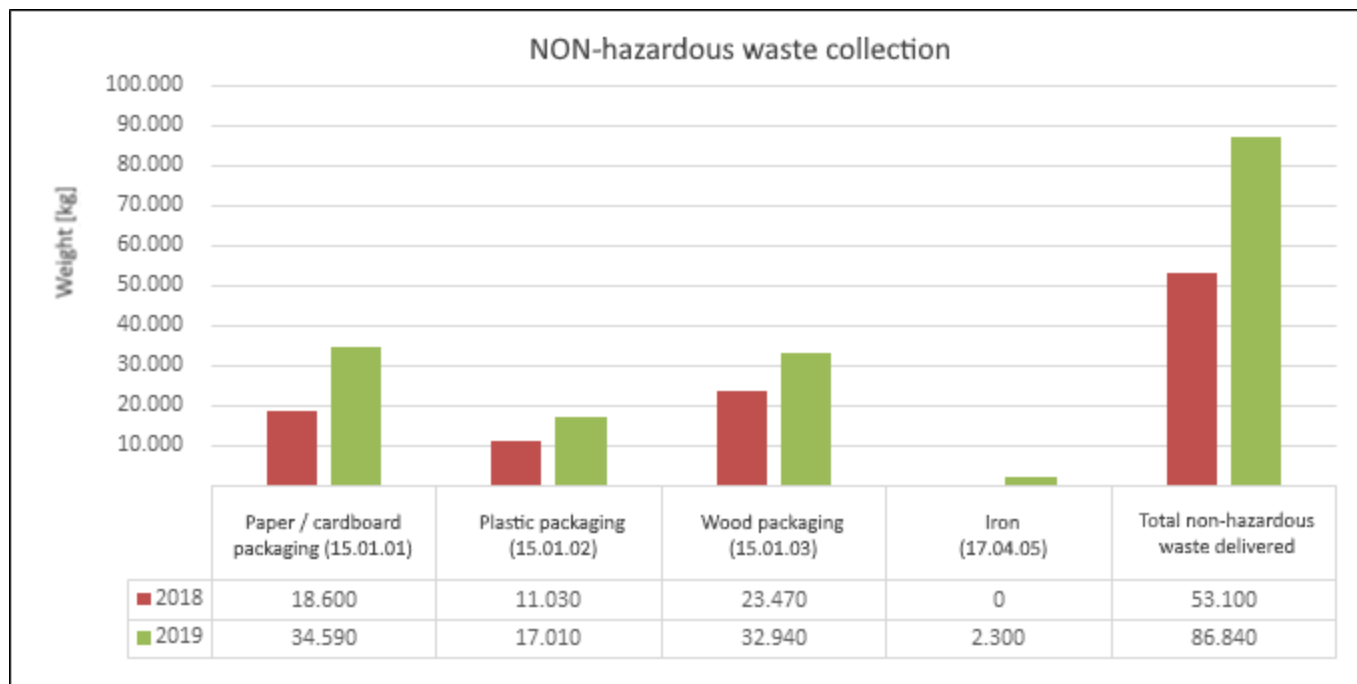

**Eterno Ivica** pay attention to waste management and workers shall apply separate waste collection of paper / cardboard and plastic packaging, which then are delivered to a specialised company for their recovery and transformation.



### 3<sup>rd</sup> long term GOAL

#### Ensuring stakeholders about the commitment to respect the environment

The Environmental Management System, certified by DNV -GL for ISO 14001, has successfully passed the inspection in date 19/06/2020 for the renewal of the certificate.

### 4<sup>th</sup> long term GOAL

#### Promote the green economy

Complete the project to obtain certification of conformity of the products to the Minimum Environmental Criteria.

### GOOD PRACTICE

In addition to having sensitized all employees to good energy saving practices, the company tries to better manage the use of paper in offices. Internally, only reams of paper with FSC environmental certifications are purchased and the used paper is differentiated to be properly disposed of.

All catalogues are available in digital format on the Company website. For the new paper reprints, we are progressively replacing it with FSC certified paper.

**Eterno Ivica** has also decided to adopt a new method of administering the paycheck, sending it directly to employees by e-mail and avoiding the monthly print.

Water dispensers connected to the water network were purchased, which allow employees to withdraw microfiltered drinking water for free. The new dispensers replaced the previous ones that used plastic bottles, thus eliminating the transport operations for refuelling and subsequent disposal once finished.





## 10 INTEGRATED MANAGEMENT SYSTEM

### Integrated Management System: Quality - Social Responsibility - Safety - Environment

The Integrated Management System is certified by DNV GL for the standards:

- UNI EN ISO 9001:2015
- UNI EN ISO 14001:2015
- SA8000:2004

The organization passed in 2019:

- the annual surveillance audit for ISO 9001;
- the annual surveillance for the maintenance of ISO 14001 certification and the scope extension to insert the plastic molding production process in the scope;
- the audit for the renewal of the certification SA 8000.

**Eterno Ivica** has a management system that respects the standards of the norms ISO 9001:2015, ISO 14001:2015, SA 8000:2004 e ISO 45001:2018.

- **the documentation is drawn up according to the new common structure called High Level Structure (HLS)**
- **It is carried out the understanding and determining the factors of the external and internal context;**
- **stakeholders and their needs and expectations are identified;**
- **risks and opportunities are assessed in relation to the needs of interested parties and related treatments;**
- **verification of results**
- **strategies and improvements to be adopted following what emerged in the analysis and evaluation activities are defined;**
- **training for all staff**

Quality and environmental risk assessment was developed with the support of the function managers and the social risk assessment was elaborated with the collaboration of the SPT Committee (Social Performance Team).

The SA8000 workers' Representatives and the Management Representative for SGS participate in the SPT and CSS Committees and were involved in the Periodical Meeting on Safety to discuss issues related to the safety in workplace with the Members of the Prevention and Protection Service ( RSPP - Doctor - RLS – Consultant ) and have actively participated in the Review of the Social Accountability Management System (SGS SA8000) and Health and Safety (SGS)

A copy of the review has been given to the RLS SA8000 (Representative for Workers' Safety) for communication and consultation of employees.

The Social Reports have been published on the company website and delivered to the Workers' Representatives.

All stakeholders have been informed about the publication of the new Social Report by email newsletter

## Structure of the integrated management system

**Eterno Ivica** applies an Integrated Management System that includes Quality, Social Responsibility, Safety and Environmental Management.

The Integrated Management System is managed through a structured documentation which includes:

- **the Integrated Management System Manual**, which describes the System, the activities put in place for the implementation of corporate policy and the definition of roles and responsibilities required to be in compliance with relevant regulations;
- **the procedures**, elaborated in order to provide a detailed description and documentation of the activities to be undertaken in compliance with the standards: ISO 9001, SA 8000, ISO 45001, ISO 14001, Legislative Decree no. 81/08 art. 30.
- **the instructions**, established in order to provide a more detailed and documented description of the operating procedures applied to undertake particular activities;
- **a register of legislation**, drawn up in order to identify, document and ensure easy access to international and national legal regulations concerning the requirements of the standard references;
- **records** which provide evidence that the system is operating and properly managed.

**All workers and new employees recruited, even temporary, have been provided with training programs for the safety update training**, with regard to Legislative Decree no. 81/08 and Agreement State-Regions, through internal and external training courses on issues including Health and Safety in the workplace, environment, quality and awareness of SA8000.

Within the Integrated Management System, monitoring and measurement activities, aimed to ensure the suitability of the Management System with the requirements of ISO 9001, SA 8000, ISO 45001, ISO14001 are undertaken in **Eterno Ivica** in order to ensure compliance to requirements.

As regards the monitoring of suppliers, it is constantly granted through the application of a procedure specifically dedicated. The application of this procedure also requires the periodic evaluation of suppliers with particular attention to critical suppliers.

The Management periodically reviews its policy for Quality, Social Responsibility, Safety and Environment, with particular regard to **adequacy** and **effectiveness**.

The effectiveness of business practices are therefore evaluated, as well as the opportunities for change and improvement of the objectives, the policy and the Integrated Management System, and new goals are set.

**Eterno Ivica** has established, by means of procedures, the procedures for the selection and qualification of suppliers/subcontractors, according to their capacity to respect the environment and the requirements of the SA8000.

By informing them about the path taken by **Eterno Ivica** in terms of Quality, Social Responsibility, Safety and Environment, the suppliers were asked the commitment to comply with these requirements, completing a self-assessment questionnaire and expressing their willingness to accept audits.

**The employees can make complaints or give tips, also anonymously, concerning matters of nonconformities related to the application of the SA8000 standard.**

The complaint process has been made available to all employees through a dedicated procedure.

**Complaints can be made via mailbox to be found in the company, dedicated to the collection of reports/complaints and through the references listed in the company policy.**

**The data and information contained in this Report are widespread in order to raise awareness of the company policy and to request suggestions and comments from the Stakeholders for the continuous improvement of the company's social responsibility and sustainable development.**

| <b>Issuer sector</b><br><b>Quality Management</b> | <b>Approved</b><br><b>General Direction</b> | <b>Issuing date</b> | <b>Reference year</b> |
|---|---|---------------------|-----------------------|
| Vescovo Damiano                                   | Favero Gabriele                             | 20/07/2020          | 2019-2020             |